

# Computer Networks

## Physical Layer - Technologies

Prof. Dr. Oliver Hahm

2024-11-21

### Agenda

<b>Transmission Media</b>	<b>1</b>
Guided Transmission Media . . . . .	3
Unguided Transmission Media . . . . .	14
The Last Mile . . . . .	18
<b>Technologies</b>	<b>20</b>
Ethernet . . . . .	21
Wireless Local Area Network (WLAN) . . . . .	24
Bluetooth . . . . .	29

### Recap: Physical Layer

- **Transmits the ones and zeros**
  - Physical connection to the network
  - Conversion of data into signals
- Protocol and transmission medium specify among others:
  - The data encoding on the transmission medium
  - The directional dependence of data transmission
  - The mechanical and electronic aspects (e.g., access point plug design, pin usage)

### Transmission Media

#### Classification of Transmission Media

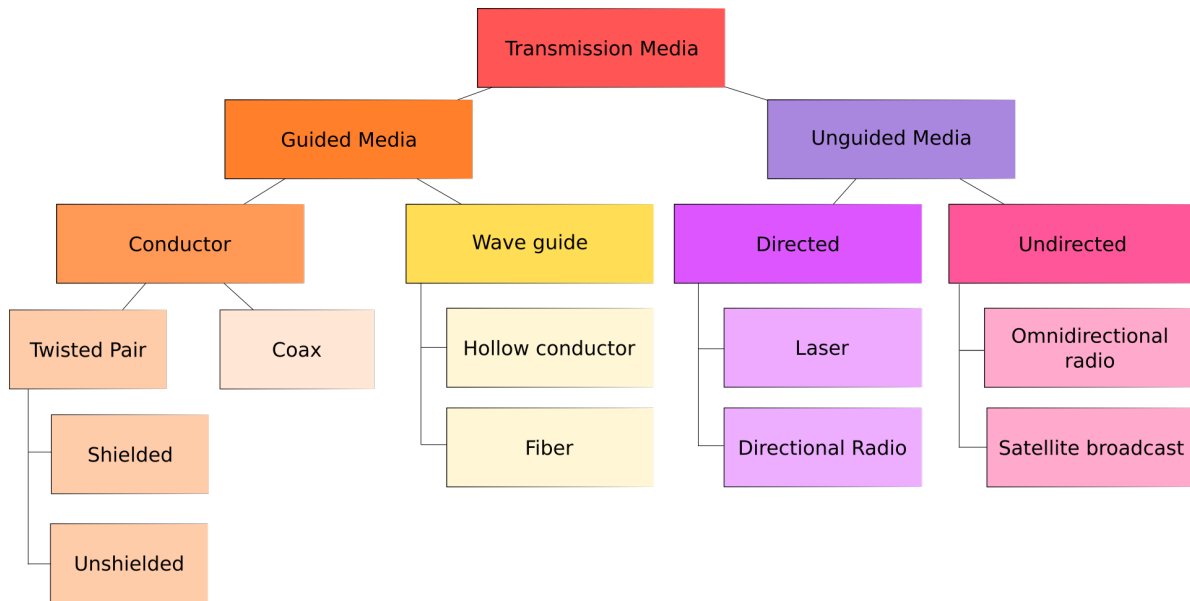

### Electromagnetic Spectrum

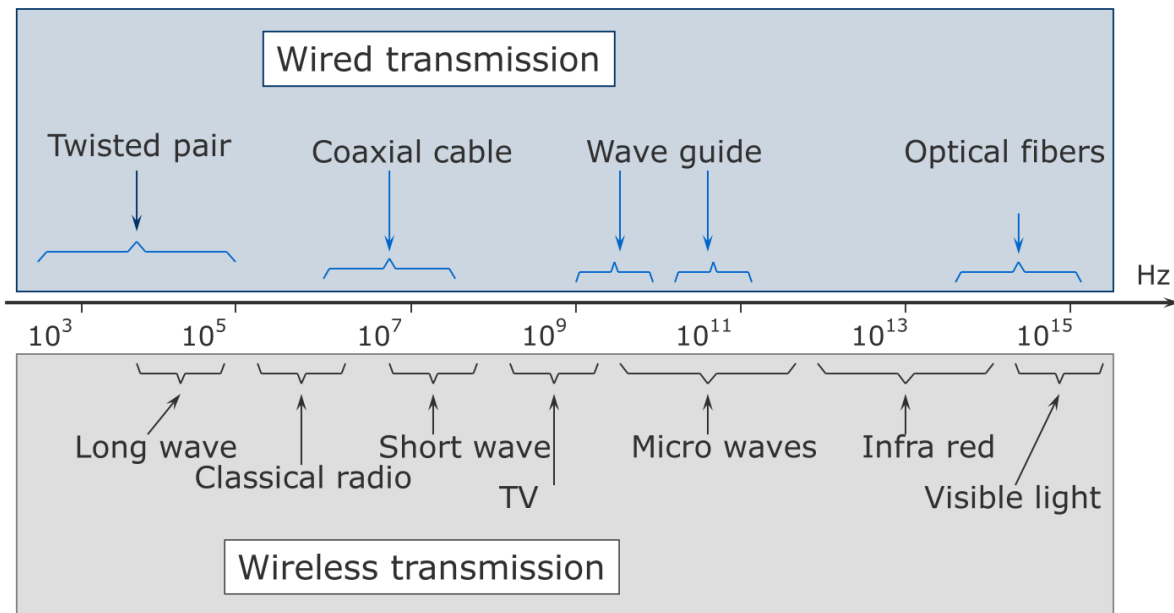

## Guided Transmission Media

### Copper Cable

---

#### Coaxial Cables (*Coax Cables*)



↑  
**Pastic jacket (PVC)**

↑  
**Outer conductor 'Shield' (aluminium)**

↑  
**Insulator (PE)**

↑  
**Inner conductor 'Core' (copper)**

- Bipolar cable with concentric (coaxial) structure
- The inner conductor (core) carries the electrical signals
- The outer conductor (shield) is kept at ground potential and completely surrounds the inner conductor
  - The shielding of the signal-carrying conductor by the outer conductor that is kept at ground potential, reduces electromagnetic interferences

#### Twisted Pair Cables

- The wires of twisted-pair cables are pairwise twisted with each other.
- Twisted pairs are better protected against alternating magnetic fields and electrostatic interferences from the outside than parallel signal wires
- All variants of the Ethernet standard, that use twisted pair cables as transmission medium, use plugs and jacks according to the standard 8P8C, which are usually called RJ45 (Registered Jack)

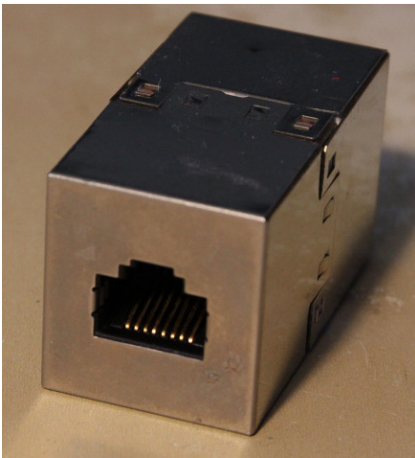
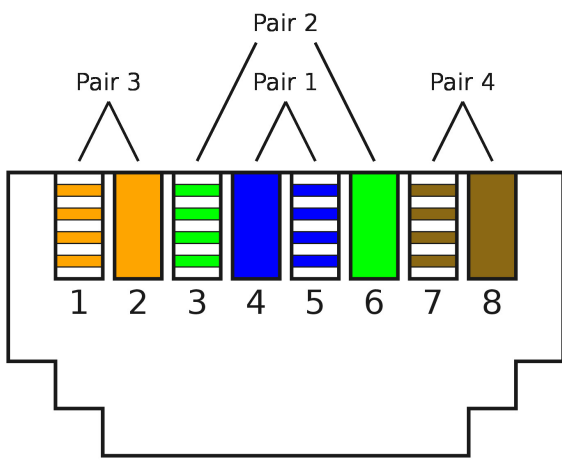
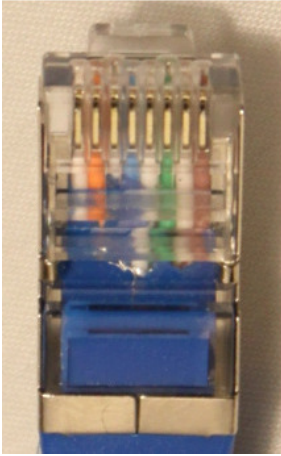

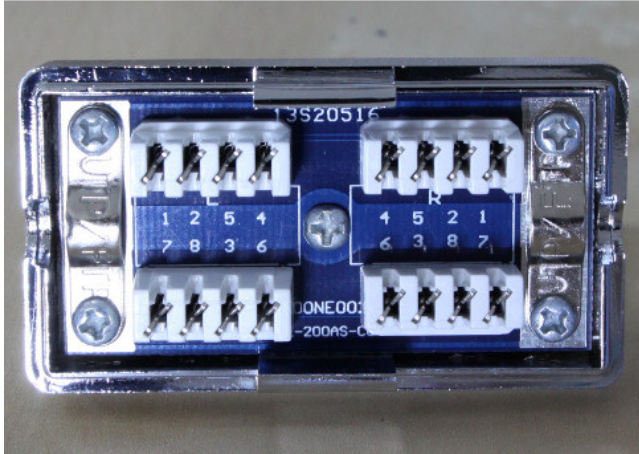

### Crossover Cables and Patch Cables

- A Crossover cable can connect 2 terminal devices directly
  - It connects the send and receive lines of both devices
- To connect more than just 2 network devices, patch cables are used
  - In this case, a hub or a switch is required

## Patch Cable

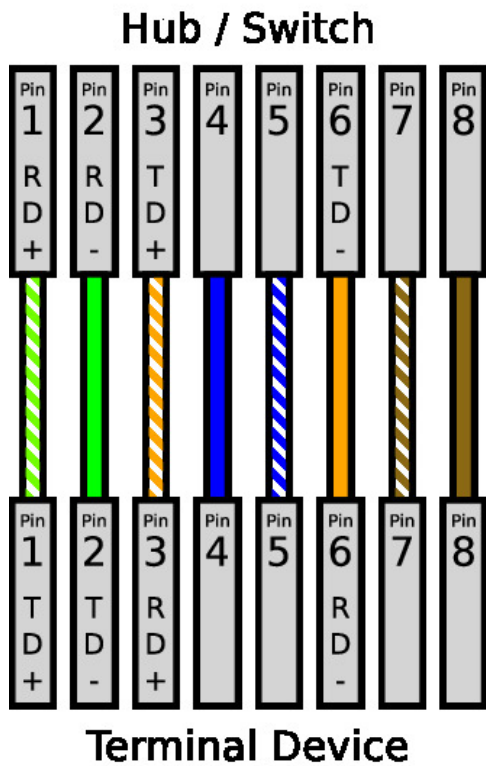

## Crossover Cable

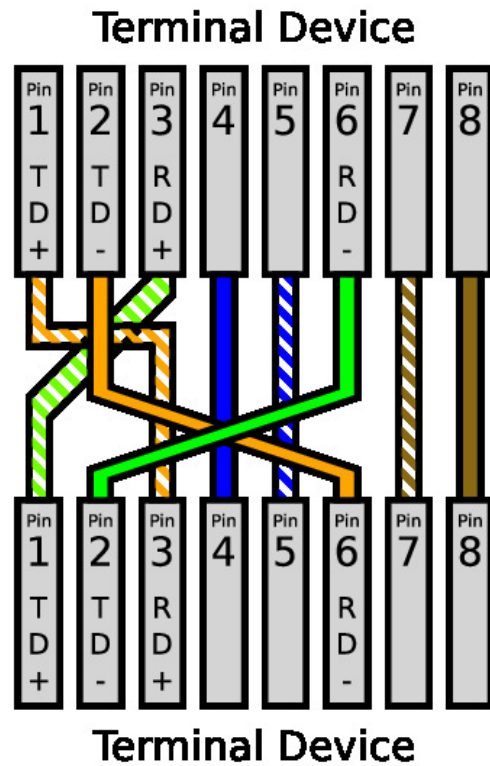

Most modern network devices support Auto-MDIX which allows to automatically detect the send and receive wires of connected network devices

- Some older switches (or hubs) provide an uplink port for connecting another hub or switch
  - The uplink port is internally crossed



## Shielding of different Twisted Pair Cables

- Twisted pair cables are often equipped with a metal shield to prevent electromagnetic interferences
- The pairs or the entire cable can be shielded (braided or foil)
- Shielding can only be used if both sides of the cable have the same ground potential

Example 1: UTP

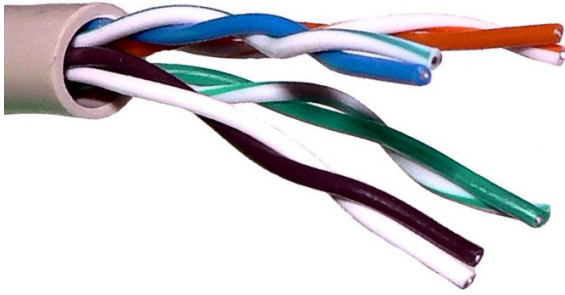

Image Source: Wikipedia (CC0)

Example 2: FUTP = FTP

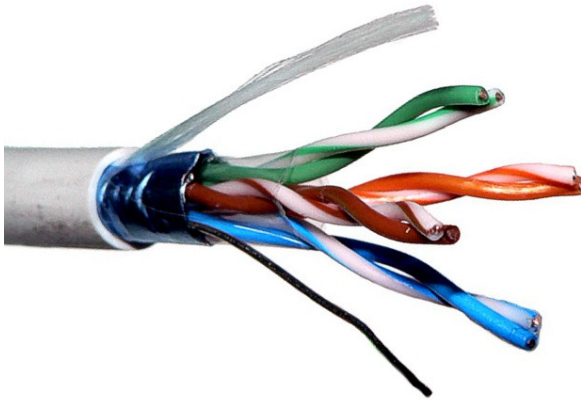

Image Source: Wikipedia (CC0)

Example 3: SFTP

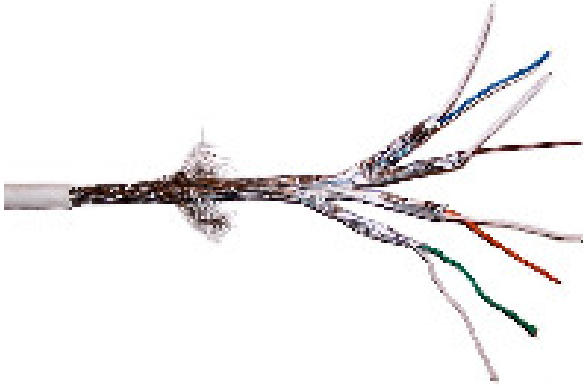

Image Source: Wikipedia (CC0)

Structure (SFTP)

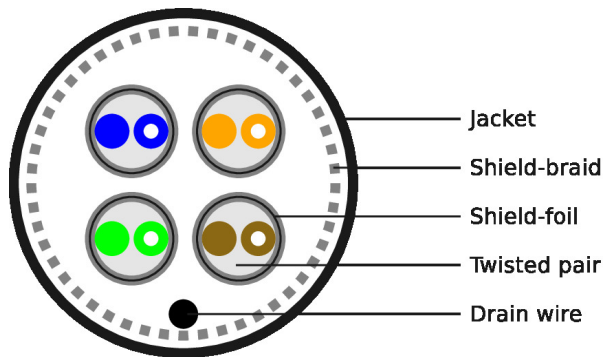

Image Source: Wikipedia (CC0)

### Categories of Twisted Pair Cables

- Different categories of twisted pair cables exist
- The performance of a network connection is determined by the component of the lowest category
  - Category 1/2/3/4 are only used for telephone cables today
  - Category 5/5e are common in most current LANs
  - Category 6/6A are compatible with up to 10 Gbps over 100 m
  - Category 7/7A do not offer benefits over Cat-6A cables
  - Category 8 are designed for data centers and support to  $\approx 30$  m length



Main differences between the categories:  
number of twists per wire length (cm) and thickness of the jacket

- **More twists** per cm  $\implies$  **less interference** (noise)
  - Cat 5/5e has 1-2 twists per cm. Cat 6 has 2 or more twists per cm
- Thickness of the **cladding**  $\implies$  **less crosstalk**
  - Crosstalk is the mutual interference of parallel lines

### Information printed on Twisted Pair Cables

- PATCH/CROSS/CROSSOVER: see [this slide](#)
- UTP/STP/FTP/SFTP: see [this slide](#)
- CAT5/5E/6/7/8: see [this slide](#)
- 24AWG/26AWG/28AWG: American wire gauge (AWG) informs about the diameters of the wires
  - 24AWG = 0.51054 mm, 26AWG = 0.405 mm, 28AWG = 0.321 mm
  - Larger wire diameter  $\implies$  less electrical resistance for the electronic signals  $\implies$  lower attenuation
  - Thinner cables block airflow in server racks less and simplify the installation
- 60°C/75°C: Temperature information stands for flame tests
- **SOLID/STRANDED**

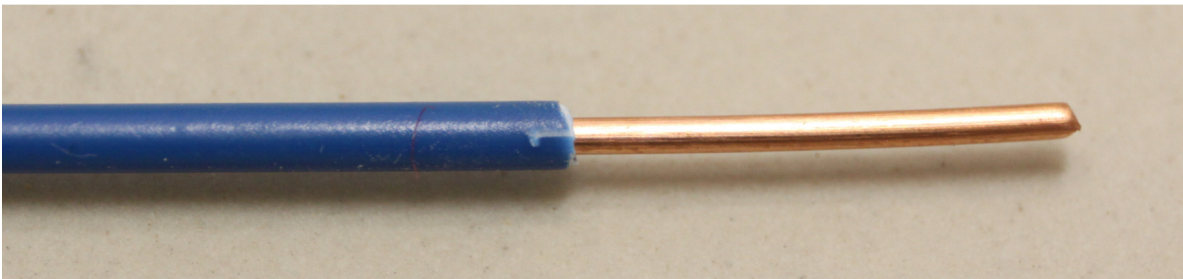

Solid cable

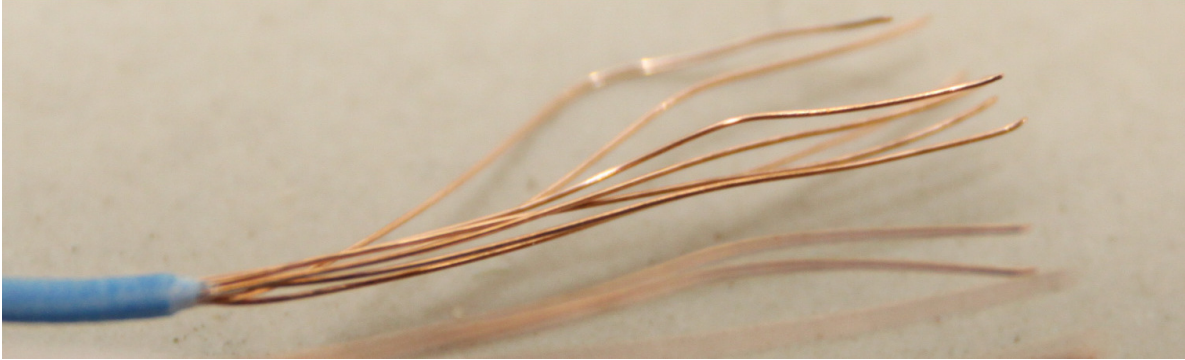

Stranded cable

Do you understand the most important cable characteristics that are printed on twisted pair cables?

**Example:**

E188601 (UL) TYPE CM 75°C LL84201 CSA TYPE CMG FT4 CAT.5E PATCH CABLE TO TIA/EIA 568A STP 26AWG STRANDED

**Fiber-optic Cables**

**Fiber-optic Cables**

- Often called optical fiber
- Transfer data by using light
  - Light source: Normal LED or laser LED
  - Use wavelengths of 850, 1300 or 1550 nm
  - Propagation speed of the light in the glass: about 200,000 km/s
- Advantages over coaxial and twisted pair cables
  - Provide high data rates over large distances
  - Create no electromagnetic emission
  - Insensitive against electromagnetic influences
- Drawbacks:
  - Higher cost for cabling and active components (LEDs)
  - Existing twisted pair cable infrastructures can not be used
- Used only when copper cables cannot provide enough bandwidth

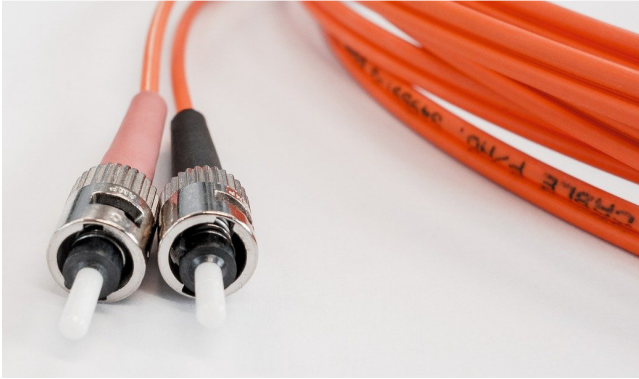

Image Source: pixabay.com (CC0)

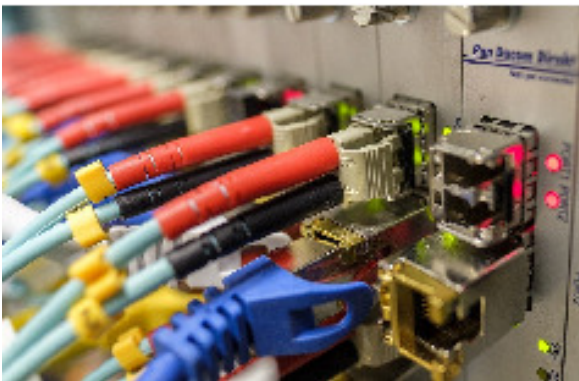

Image Source: pixabay.com (CC0)

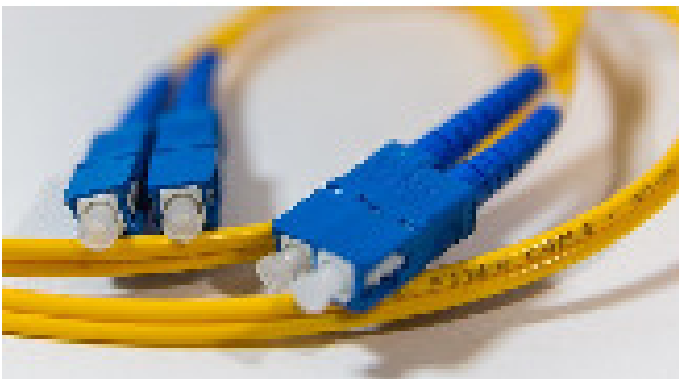
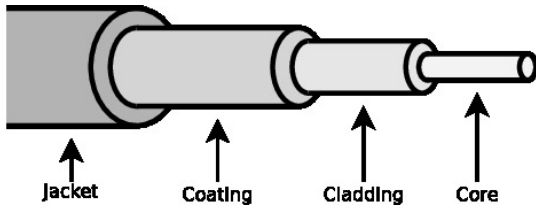

Image Source: pixabay.com (CC0)

### **Structure of Fiber-optic Cables**

- Components of an optical fiber (from inside to outside):

1. Light-transmitting (core) made of quartz glass
2. The core is surrounded by a cladding layer
  - The refractive index of the core must be greater than that of the cladding to enclose the optical signal
3. The core is surrounded by a coating layer that protects it from moisture and physical damage
4. The final layer is the outer jacket to protect the inner layers



Source: [pxhere.com](https://pxhere.com) (CC0)

### Multi- or Mono-mode Fibers

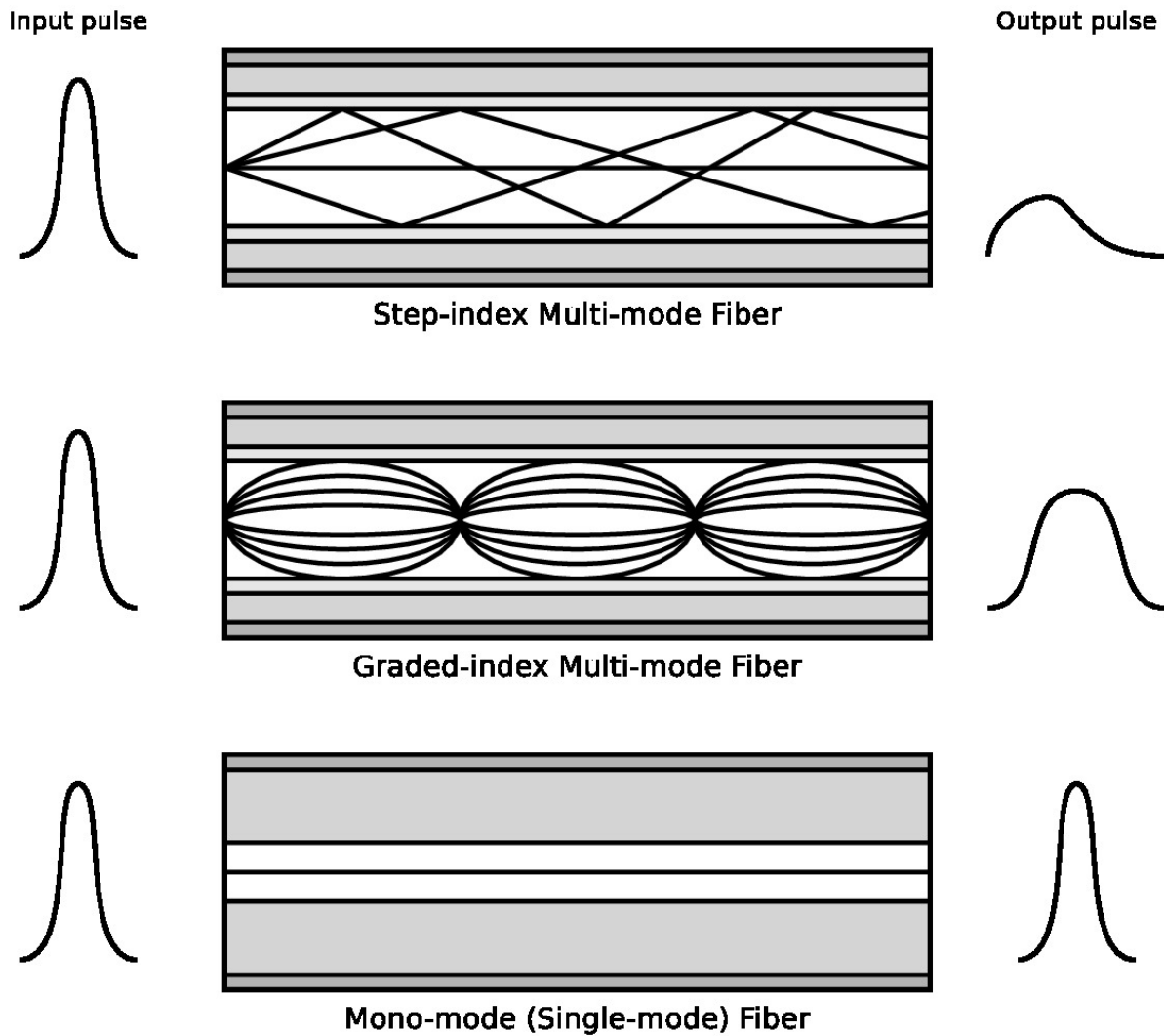

- Structure, dimensions and refractive index of core and cladding specify the number of propagation modes, by which light can propagate along the fiber
  - Each mode corresponds to one path in the optical fiber
- Multi-mode Fibers provide up to several thousand propagation modes and mono-mode (single-mode) fibers only a single one
  - Short distance ( $\approx < 500$  m)
    - $\implies$  multi-mode fibers
  - Long distance ( $\approx < 70$  km)
    - $\implies$  mono-mode fibers

For more details (German only):

<https://glasfaserkabel.de>

## Unguided Transmission Media

### Wireless Communication

- Medium is an electromagnetic wave
- Data is modulated
- The range depends on signal power and environment
- Can be directed or undirected

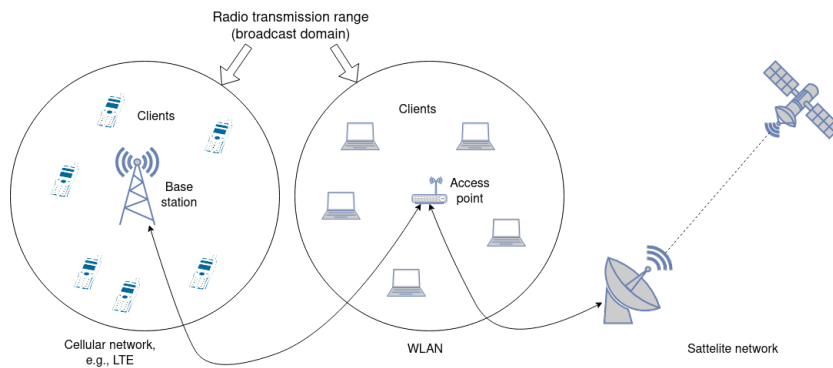

### Challenges

Which (additional) challenges do we have to face in wireless networks?

### Shared Medium

- Frequencies cannot be used arbitrarily but must be allocated

# UNITED STATES FREQUENCY ALLOCATIONS

THE RADIO SPECTRUM

ADMINISTRATIVE DESIGNATION

ACTIVITY CODE

CLASSIFICATION DESIGNATION

U.S. DEPARTMENT OF COMMERCE  
NATIONAL BUREAU OF STANDARDS  
FEDERAL COMMUNICATIONS COMMISSION

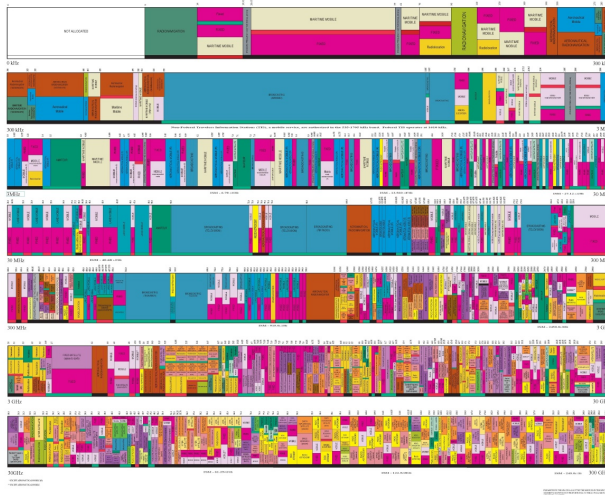

## Challenges of Wireless Networks

### 1. Fading over distance (decreasing signal strength)

- Electromagnetic waves are gradually weakened by physical barriers (e.g., walls) and in free space

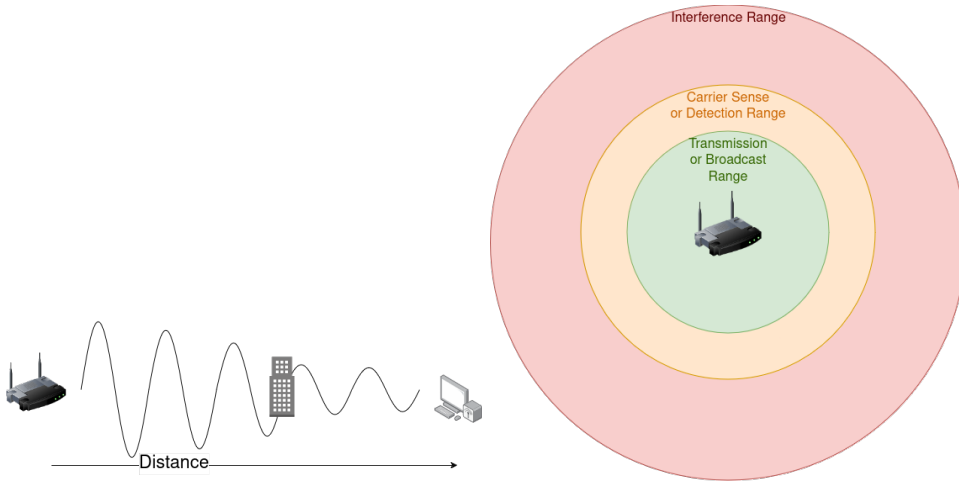

### 2. Exposed terminal problem

- A node is prevented from sending packets to other nodes because of being within transmission range of a neighboring transmitter

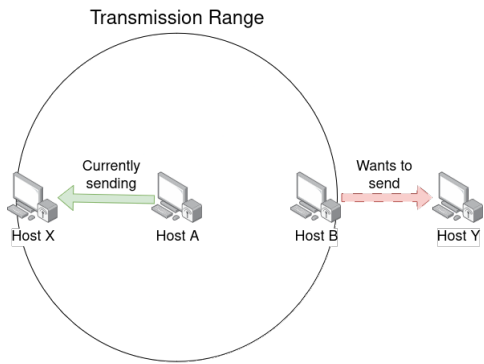

### 3. Hidden terminal problem (invisible or hidden terminal devices)

- Terminal devices, communicating with the same device (e.g., an access point), do not recognize each other and therefore interfere with each other

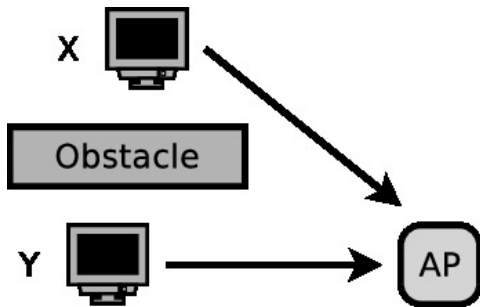



#### 4. Multipath propagation

- Electromagnetic waves are reflected and therefore go paths of different lengths from the sender to the destination
  - Result: A difficult to interpret signal arrives at the receiver because the reflections influence subsequent transmissions
- Similar problem: If objects move between sender and receiver, the propagation paths may change

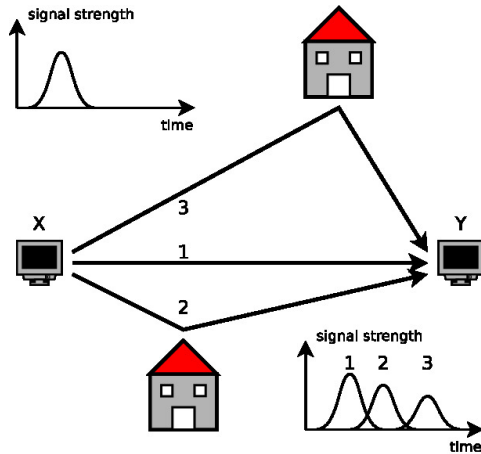

#### 5. External Interference

- Examples: WLAN and Bluetooth operate in the same spectrum
- Also electromagnetic noise, caused by motors or microwave ovens can cause interferences



## The Last Mile

### Bridging the Last Mile

How can we connect a plethora of users to the Internet in a cost-efficient manner?

- **Most common solutions**
  - **DSL:** Access through phone lines
  - **Cable:** Access through television broadcast system
  - **3G/4G:** Access through deployed cellular networks
- **Other solutions**
  - **Powerline:** Access through AC infrastructure
  - **Satellite:** E.g., using television satellites
  - **Wireless:** E.g., WiMAX, directed WIFI
  - **Fiber:** Requires infrastructure expansion

### History: The Classical Modem

- A modem modulates/demodulates digital data over an analog medium
- The telephone system transmit the data the same way as normal audio signals (i.e., phone calls)
- The modem takes care of the signaling information
- High error rate
- Speed: up to 56 kpbs



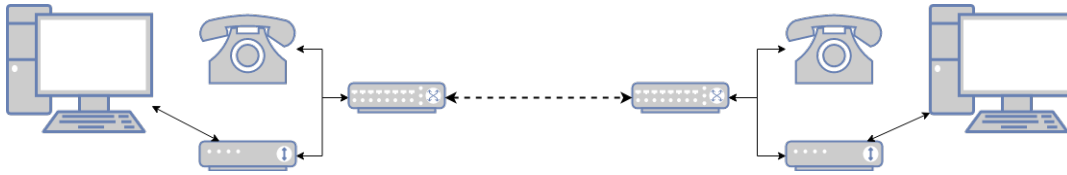

## Digital Subscriber Line (DSL)

- Use the whole spectrum of the copper cable
- Downstream modulation via DSL modem, upstream modulation via DSL Access Multiplexer (DSLAM)
- Modulation with Discrete Multi-tone Modulation (DMT) or Carrierless Amplitude Phase Modulation (CAP)
- Data rate depends on distance to the switching center and the cable quality
- The VDSL2 (Very high bit rate digital subscriber line 2) standard allows up to 100 Mbps at 500 m (using frequencies up to 30 MHz) <sup>1</sup>



Source: Wikipedia, CC 2.0

## Data Over Cable Service Interface Specification (DOCSIS)

- Reusing the cable television infrastructure (using coaxial cables)
- Downstream modulation via cable modem, upstream modulation via Cable Modem Termination System (CMTS)
- Channels from low-end radio spectrum (6–8 MHz)
- Downstream up to 160 Mbps, upstream up to 20 Mbps

<sup>1</sup>ITU recommendation G.993.2, published in 2006

- Modern architectures allow for higher data rate because of hybrid fiber/coaxial (HFC) architecture
- Shared medium
- Ratified as ITU-T recommendation



Source: Wikipedia, CC 3.0

### **3GPP Standards**

Standardization body: 3GPP (3rd Generation Partnership Project)

**GPRS (General Packet Radio Service)** → Up to 114 kbps

**UMTS (Universal Mobile Telecommunications System)** → Up to 42 Mbps

**LTE (Long Term Evolution)** → Up to 168 Mbps

**5G** up to 10 Gbps with a focus on IoT and M2M applications

## **Technologies**

### **Standardization**

- The **Institute of Electrical and Electronics Engineers Standards Association (IEEE SA)** is a subdivision of the IEEE and in charge of specifying engineering standards
  - IEEE SA is neutral community and neither legally authorized by or governed by any national government

- A family of standards developed and published by the IEEE is IEEE 802
- This family include standards for PANs, LANs, and MANs
- Important working groups:
  - IEEE 802.1 Higher Layer LAN Protocols WG
  - IEEE 802.3 Ethernet
  - IEEE 802.11 WLAN (Wireless LAN)
  - IEEE 802.15 WPAN (Wireless PAN)

## Ethernet

### Ethernet (IEEE 802.3)

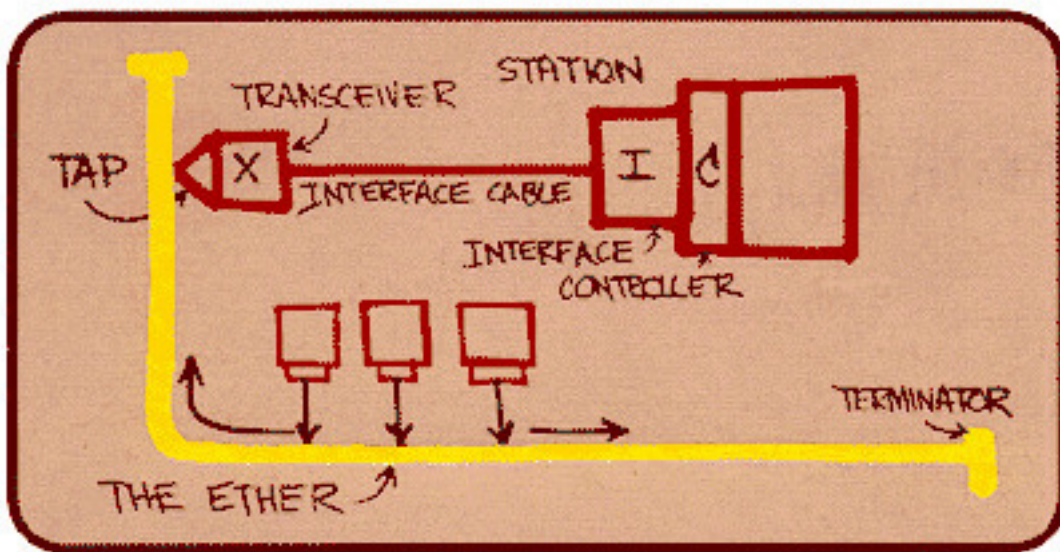

With this drawing Robert Metcalfe demonstrated in June 1976 the working principle of Ethernet on the National Computer Conference

### The Evolution of Ethernet

- From 1973 Ethernet was developed at the Xerox PARC (Palo Alto Research Center) by Robert Metcalfe and others
  - The data rate was 2.94 Mbps
  - The transmission medium was a coaxial cable

- In 1983 IEEE published the specification for 10BASE5 <sup>2</sup> as a draft (the standard followed in 1985): IEEE 802.3
  - The data rate was 10 Mbps
- In 1988 AT&T released StarLAN 10 which became the basis for 10BASE-T
  - The transmission medium were twisted-pair cables
- Since the 1990 Ethernet has become the most frequently used (wired) LAN technology

### Coaxial Cable for 10BASE5 – Thick Ethernet

- 10BASE5 (*Yellow Cable* or *Thick Ethernet*)
- 10 mm thick coaxial cable (RG-8) with 50 ohm impedance
- For connecting terminal devices, a hole must be drilled into the cable through the outer shielding to contact the inner conductor
- Through the hole, the transceiver is connected via a vampire tap with the inner conductor
- The terminal device is connected via a transceiver cable, called AUI (Attachment Unit Interface) with the transceiver

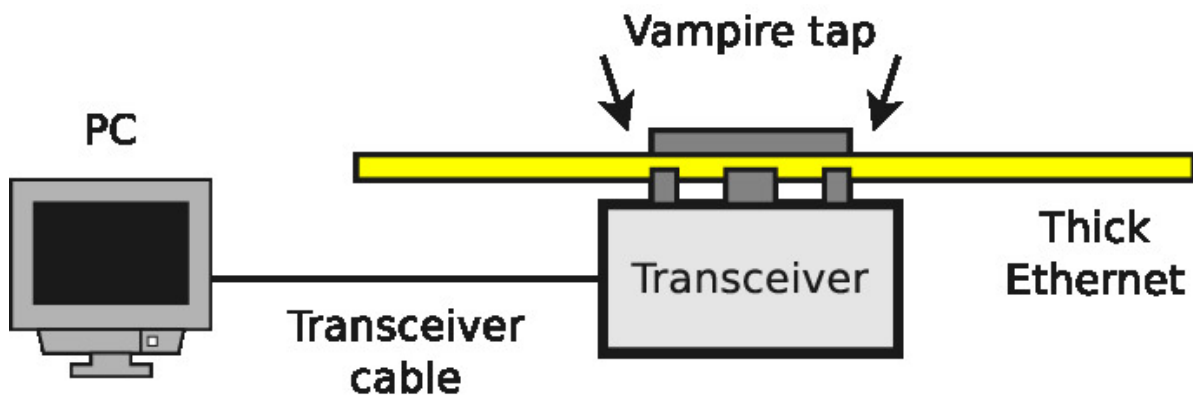



---

<sup>2</sup>Also called thick Ethernet

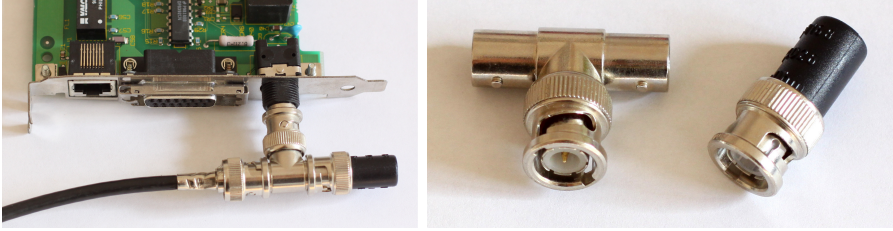

### Coaxial Cable for 10BASE2 – Thin Ethernet

- The hardware required for Thick Ethernet is cost intensive
- A less expensive solution is 10BASE2
  - It is called Thin Ethernet, *ThinWire* and sometimes *Cheapernet*
- 6 mm thick coaxial cable (RG-58) with 50 ohm impedance
  - The cables are thinner and more flexible, and therefore more simple to install
- Cables and devices have BNC connectors (Bayonet Neill Concelman)
- T-Connectors are used to connect devices with the transmission medium
- Terminators (50 ohm) are used to prevent reflections



## Characteristics of Ethernet

- The Ethernet standards provide services on the Physical Layer and the Data Link Layer
- Several Ethernet standards exist, e.g., 10BASE5, 10BASE2, 100BASE-TX, 1000BASE-LX, 1000BASE-TX, 40GBASE-T
- They differ among others in ...
  - the maximum **data rate**,
  - the **transmission medium** used, and
  - the maximum segment length
- The connection type to the medium is passive, i.e., devices are only active when they send data
- Broadband variants of Ethernet exist, but were no economic success

## Wireless Local Area Network (WLAN)

### WLAN (IEEE 802.11)

- The most frequently used wireless LAN technology
- Wi-Fi is a marketing brand
- Current specifications allow up to 7 Gbps
- Multiple communication models:

**Infrastructure mode** Clients connect to an Access Point (AP)

**Ad-hoc mode** Clients can form a mesh network



## The Evolution of WLAN standards

- In 1985 the US FCC (Federal Communications Commission) released the ISM radio bands for industrial, scientific, and medical purposes, including a frequency range at 2.4 GHz
- In 1997 the IEEE released the first standard as 802.11
- 1999 IEEE 802.11b followed with a data rate up to 11 Mbps
- Later amendments like 802.11a or 802.11n make use of the 5 GHz spectrum

IEEE Standard	Maximum (gross) Data Rate	Realistic (net) Data Rate
802.11	2 Mbps	1 Mbps
802.11a	54 Mbps	20-22 Mbps
802.11b	11 Mbps	5-6 Mbps
802.11g	54 Mbps	20-22 Mbps
802.11n	600 Mbps	200-250 Mbps
802.11ac	1.733 Mbps	800-850 Mbps

## Transmission Power of WLAN

- WLAN is designed for use inside buildings
  - For this reason, it transmits with a relative low transmission power (up to 100 mW at 2.4 GHz and 1 W at 5 GHz)
    - \* Such transmission power levels are considered safe for health
    - \* For comparison, the transmission power of GSM phones, that operate in the frequency range 880-960 MHz, is about 2 W
- Why do we require more power output at 5 GHz?
- Why do we require more power for GSM?

Some WLAN devices for 2.4 GHz provide a higher transmission power

- Operating such devices is illegal in many countries



**Wifi Verstärker 1000mW**  
 Professionell WLAN Booster / Verstärker 1000mW (30dBm) 2.4GHz 802.11b/g bis 108Mbps

**Ihre Vorteile:**

- Vergrößern der Reichweite bis zu 100m
- Kanal mit Signalstärke bis zu 100dBm
- Kompatibel mit 11Mbps Daten bis zu 100Mbps Daten
- Unterstützt alle Standards: 802.11b/g/n
- Unterstützt alle Standards: 108Mbps
- Keine Drucker zum Anschließen
- Mit USB-Booster / Verstärker 1000mW (30dBm) kompatibel

**Lieferumfang:**

- 1x Verstärker
- 1x Bedienungsanleitung
- 1x USB-Kabel
- 1x Antenne

**Jetzt mit 30dBm**  
und 2000mW (30dBm)

**ALFA NETWORK**  
**1000mW 5dBi**  
**Plus Mount!**

## WLAN Standards, Frequencies and Channels

- Most WLAN standards use the frequency blocks 2.4000-2.4835 GHz and 5.150-5.725 GHz in the microwave range
  - The standards differ among others in the frequency blocks used, data rates and modulation methods, as well as the resulting channel width

IEEE Standard	Published in	2.4 GHz	5 GHz
802.11	1997	X	
802.11a	1999		X
802.11b	1999	X	
802.11g	2003	X	
802.11n	2009	X	X
802.11ac	2013		X

Despite the fact that WLAN is used worldwide, legal differences exist

**Example:** In Germany, using 5.15-5.35 GHz is only allowed in enclosed rooms with 200 mW maximum transmission power

## Non-overlapping Channels of IEEE 802.11b

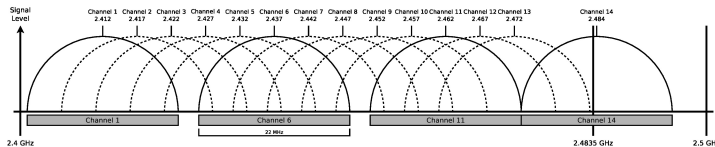

- IEEE 802.11b uses the Direct Sequence Spread Spectrum (DSSS) modulation scheme with 22 MHz wide channels and 5 MHz channel spacing
  - Thus, only 3 (EU and U.S.) or 4 (Japan) channels exist, whose signals (in theory) do not overlap
    - \* Channel 1, 6, 11 and 14 (only in Japan)
- Good channel assignment is crucial in dense networks (e.g., hotels, conference centers, apartment buildings)

### **IEEE 802.11n – Multiple Input Multiple Output (MIMO)**

- MIMO uses up to four antennas
- These can be used in different frequency blocks in 2.4 GHz and 5 GHz in parallel
- In 802.11n MIMO increases the gross data rate to up to 600 Mbps
- With each parallel data stream (antenna), a maximum data rate (gross) of 150 Mbps can be achieved and up to 4 data streams can be bundled



Source: pixabay.com, CC0

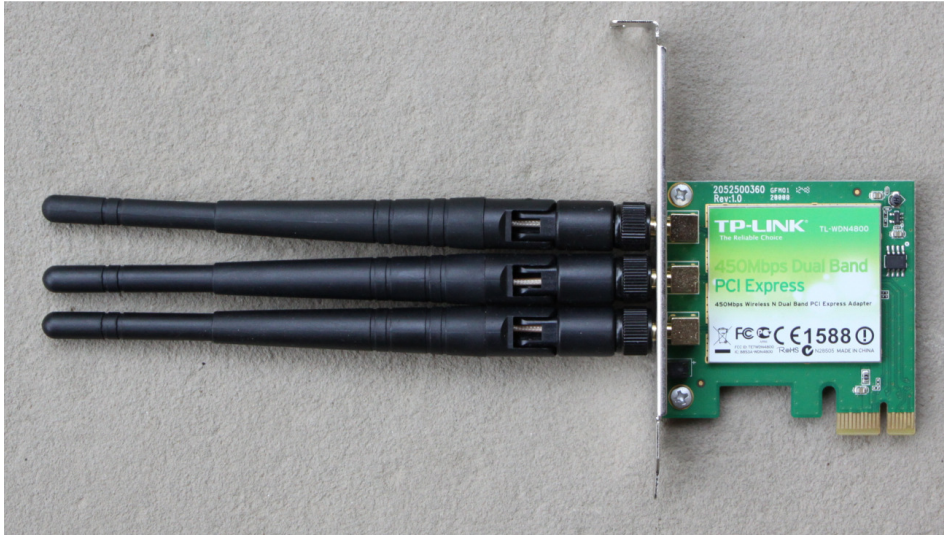

Source: Christian Baun

### **WLAN Security: WEP**

- 802.11 implements the security standard Wired Equivalent Privacy (WEP)
  - Based on the RC4 algorithm
  - Works with static keys that have a length of 40-bit or 104-bit
  - The mechanism can be cracked in reasonable time because of the predictable protocol headers

### **WLAN Security: WPA**

- Modern security standards are Wi-Fi Protected Access (WPA) 1/2/3
  - Original WPA is based on the RC4 algorithm, WPA2 uses the Advanced Encryption Standard (AES)
  - Works with dynamic keys (based on Temporal Key Integrity Protocol (TKIP) or encrypting each data packet with a different key)
  - WPA2 includes the more secure encryption protocol Counter-Mode/CBC-Mac Protocol (CCMP)
  - WPA3 replaces the Pre-shared key (PSK) exchange with Simultaneous Authentication of Equals (SAE)
  - WPA2 encryption with a sufficiently long password is still considered secure, WPA1 not
  - Instead of PSK a RADIUS authentication server (WPA-Enterprise) or Wi-Fi Protected Setup (WPS) can be used for key distribution

## Bluetooth

### Bluetooth

- Wireless network system for short distance data transmission → BANS
  - It is designed to replace short cable connections between different devices
- Development was initiated by the Swedish company Ericsson in 1994
  - Further development is done by the Bluetooth SIG (Special Interest Group)

Bluetooth is named after the Danish Viking King Harald Bluetooth. He was famous among other things for his communication skills.



Source: Wikipedia, CC 2.0

### Bluetooth Characteristics

- Bluetooth devices use the frequency block 2.402-2.480 GHz
- Frequency hopping is used to avoid interference with, for instance, WLAN

### Network Topologies of Bluetooth

- Bluetooth devices organize themselves in so-called piconets
  - A piconet consists of up to 255 nodes
  - One active node is the master, the others are slaves

\* The master can change the status of the other nodes (activate/deactivate)

- Each Bluetooth device can be registered in multiple piconets
- If a node in range of 2 piconets, it can combine them to a Scatternet

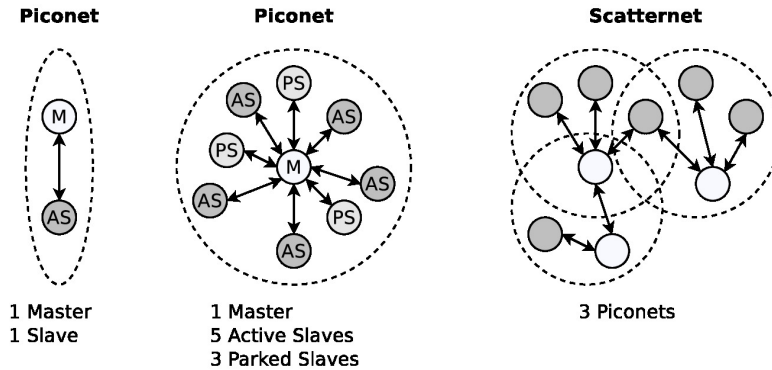

## The Evolution of Bluetooth

- Development started in 1989 at Ericsson for wireless headsets
- The first consumer device (a headset) was launched in 1999
- Initial data rate is some hundred kbps
- Version 2.0 introduces Enhanced Data Rate (EDR) and allows for up to 2.1 Mbps
- In 2010 Bluetooth 4.0 was published and introduced Bluetooth Low Energy (BLE)
- RFC 7668 is published in 2015 and specifies IPv6 over BLE
- Bluetooth 5.0 was released in 2016 and is targeted to support IoT use cases
- The current data rate allows for up to 50 Mbps

## Pairing of Bluetooth Devices

- The initial key exchange between two Bluetooth devices is called pairing
- Older Bluetooth versions (before 2.1) required to enter a PIN as a PSK
- Bluetooth 2.1 introduced Secure Simple Pairing
  - The Diffie-hellman algorithm is used for key exchange
  - The capabilities of the device determine the security mechanism to be used
- The bonding process allows to establish a longterm trust relationship between two devices

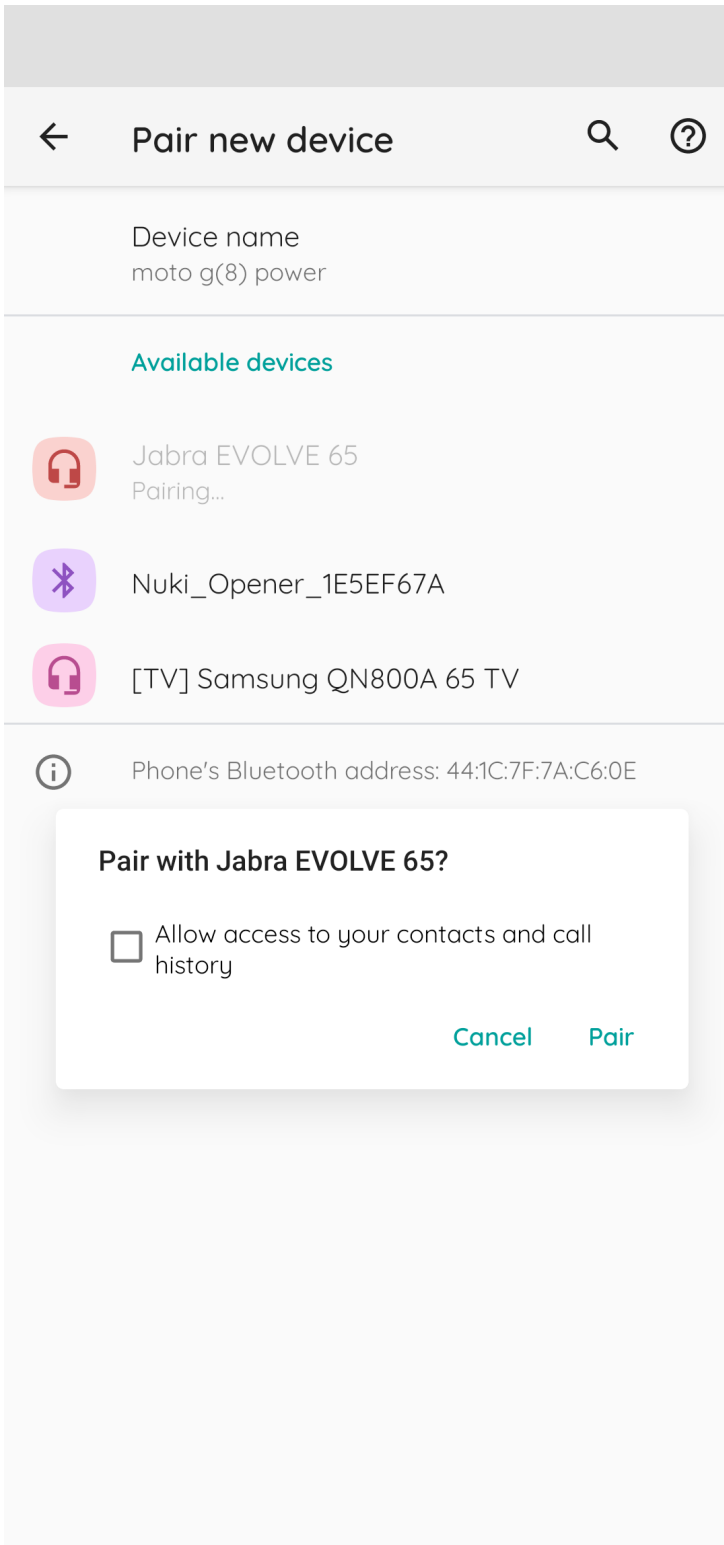

## Summary

You should now be able to answer the following questions:

- What are common transmission media and what are their most important properties?
- Which challenges arise particularly in wireless networks?
- How can existing infrastructure be used to bridge the last mile?
- Which common technologies are used on the physical layer?

